

HIGHBAY APPLICATIONS

NLV Lighting UFO High Bay luminaires are designed for a wide variety of applications for use in warehouses, manufacturing, gyms, parking lots, and other industrial buildings. These fixtures are designed for 15 ft to 40 ft ceilings. The extruded heat sink design has a full body construction that provides durability and thermal control. All luminaires come with a high-quality glass lens providing added protection and glare control. These fixtures are energy-efficient replacements for linear fluorescent and HID fixtures.

PRODUCT FEATURES

- Power Range: 50W to 300W
- Efficacy Range: 130 to 160 LM/W
- Multiple CCTs from 3000K to 6000K
- Operating Temperature: -40°C to 50°C
- Tier-1 LED suppliers; LM80 rated at CRI >80
- 120V to 277V and 120V to 347V
- PF >0.90, THD ≤ 20%
- Multiple beam angle reflectors from 60 deg to 120 deg.
- Emergency battery back up option
- Motion Sensing and Dimming
- Standard 5 Year warranty



PHYSICAL DIMENSIONS

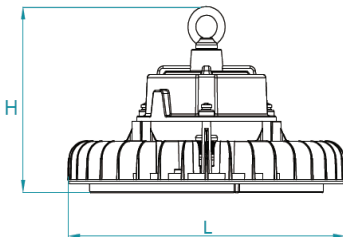

Power (W)	Dimensions (L x H)
100	10.24 x 6.26
150	10.24 x 6.85
220	
240	12.60 x 6.73
300	12.60 x 7.80

PRODUCT OPTIONS

- Standard Dimming 0-10V or remote controlled via IR sensor
- Infrared sensor or microwave motion sensor options based on application
- Emergency backup driver from 45-90 minutes lifetime
- Reflectors – 60 deg to 120 deg

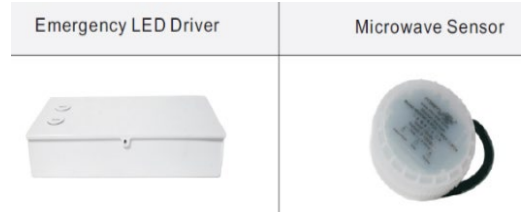

PHOTOMETRICS

Ø 10.24*6.26 inch 100W

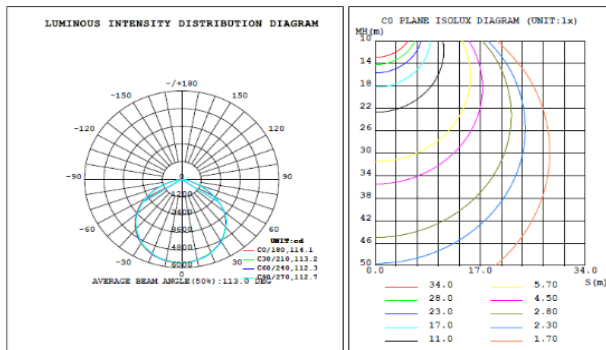

Ø 10.24*6.85 inch 150W

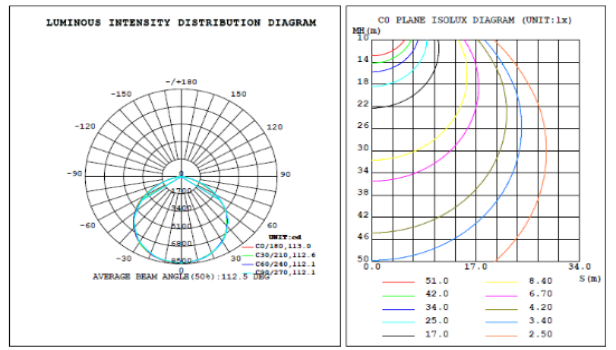

Ø 10.24*6.85 inch 200W

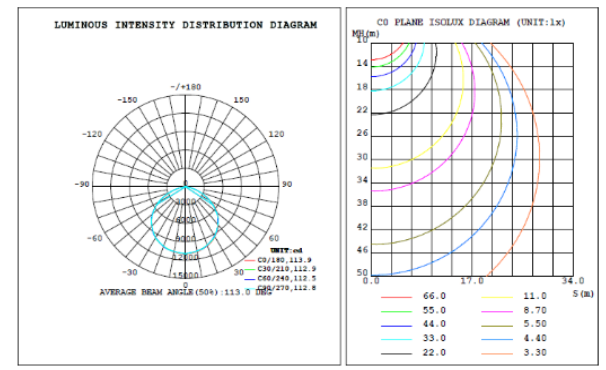

Ø 12.60*6.73 inch 240W

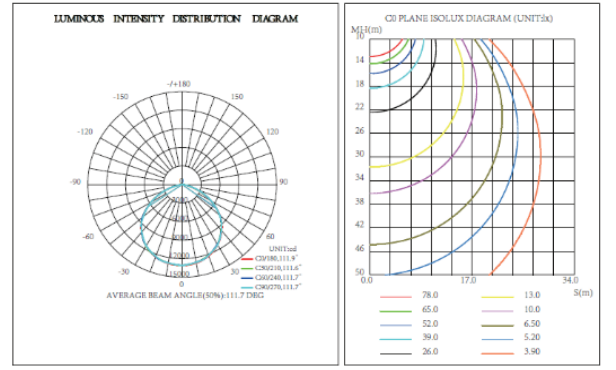

Ø 12.60*7.80 inch 300W

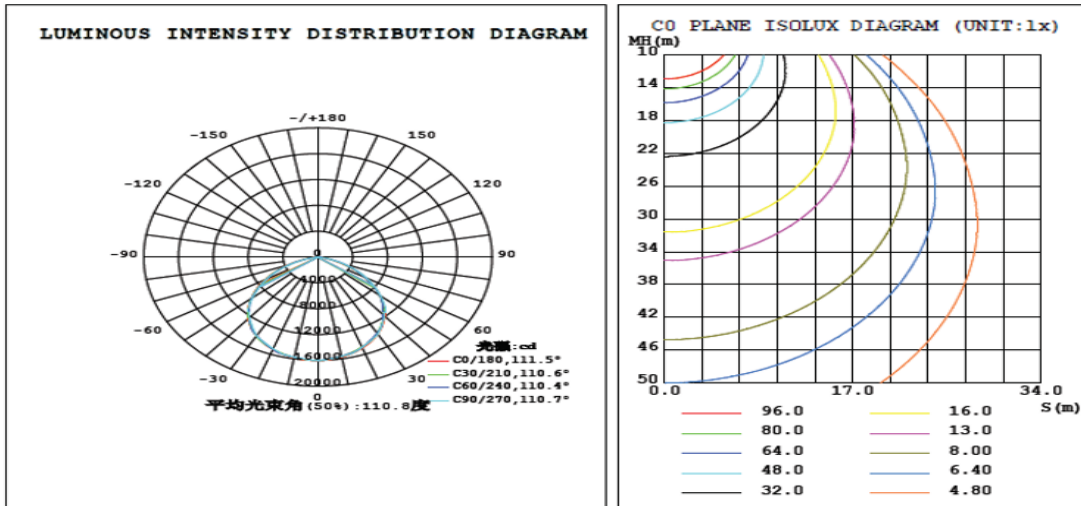

ORDERING INFORMATION

Example: UHB-RSVV-150W-57K-277V-150LPW-120D-DSE-BL

MODEL #	POWER	CCT (K)	Input Voltage	LM/W	Optics
UHB-RSV	100	30K 3000K	AC 120 - 277 V	150	060 60 deg 090 90 deg 120 120 deg
	150	35K 3500K			
	200	40K 4000K	Or		
	240	50K 5000K			
	300	57K 5700K			
		60K 6000K	AC 120 – 347V	OTH	

Options:

- DDM - Dimming function
- DDS – Dimming + Sensing function
- DDE – Dimming + Emergency function
- DSE – Dimming + Sensing + Emergency function

Color :

- WH – White
- BL – Black
- CC – Custom Color

ELECTRICAL SCHEMATIC DIAGRAM

Without any function, 0(1)-10V Dimming wiring diagram

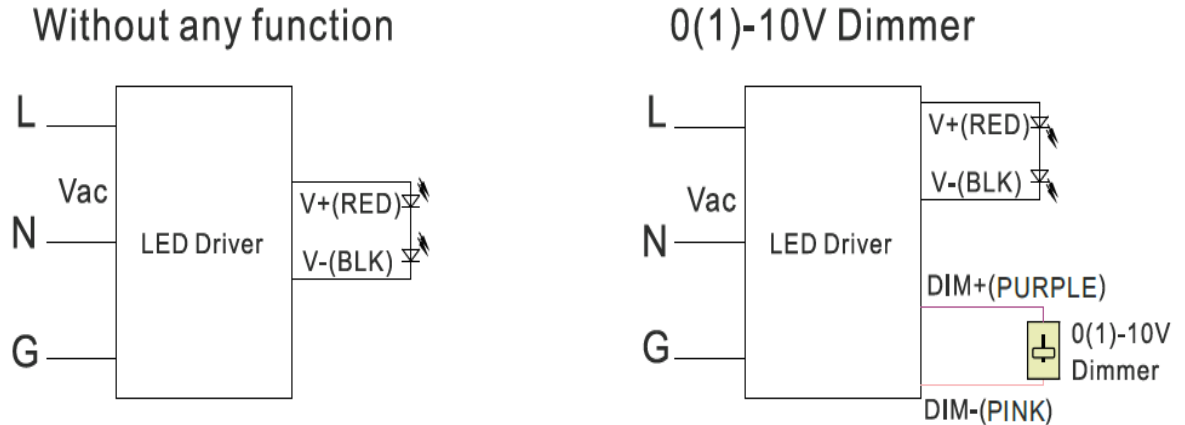

INSTALLATION - SAFETY NOTICE

The installation of these fixtures shall be done by licensed and qualified contractors only. NLV Lighting shall not held liable for any personnel or property damage.

- Turn power off before inspection, installation or removal
- Properly ground all electrical enclosures
- Follow local codes and all NEC codes
- Use only UL or IEC approved Wires and other electrical accessories required
- Check the supply voltage and protect the lighting circuit by 15 -20A circuit breaker

INSTALLATION

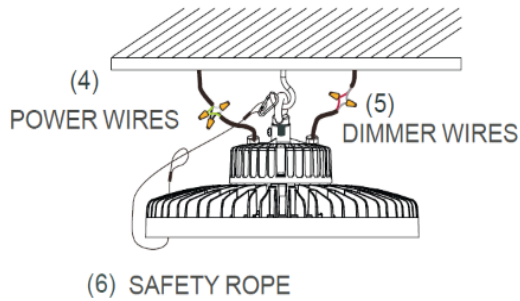

A) Hook Mounting

- If you don't need the plug, cut it off for direct wiring (refer to 4). Connect the black wire (Live Wire), white (Neutral wire) and green wire (Ground) to the appropriate wire inside junction box.
- To make the lamp dimmable, please connect 1-10V dimmer (not include) with the dimming signal of lamp, connect DIM+ port and DIM- port with corresponding line on the dimmer.

B) Metal Chain Mounting

- Screw the include MOUNTING RING clockwise into the hole at the top of the fixture and tighten.
- Ensure the SAFETY ROPE is secured on the fixture. Secure the other end of the SAFETY ROPE to the mounting structure.

